



Technical Specification

Product fiche

Trademark	Blaupunkt
Model ID	55/405V-GB-11B4-UEGQPF
Energy efficiency class	A
Visible screen size (diagonal)	139 cm / 55 inches
On mode power consumption	110.0 W
Annual energy consumption *1	161 kWh
Standby power consumption *2	<0.50 W
Off mode power consumption	n/a
Screen resolution	3840 (H) x 2160 (V)
*1: Energy consumption XYZ kWh per year, based on the power consumption of the television operating 4 hours per day for 365 days. The actual energy consumption will depend on how the television is used.	
*2: When the TV is turned off with the remote control/standby button and no function is active.	

Additional Technical Information

RF	75 ohm Antenna / Analog / DVB
Inputs	3 x HDMI, 3 x USB, 1 x SD card reader, 1 x RJ45 LAN/Ethernet, 1 x Mini-SCART, 1 x Mini Component/YPbPr, 1 x Mini AV IN - Composite Video/CVBS and L/R Audio shared for Composite Video and Component/YPbPr.
Sound Outputs	1 x Digital Optical Audio output, 1 x 3.5mm Headphone
Speaker* / Amplifier Watts (RMS)	2 x 10 + 15W subwoofer
Voltage and power consumption	AC 220V~240V; 50Hz 110/145/180 W (ecomode/standard/max)
Dimensions including stand (mm)	1242 W x 765 H x 245 D
Net weight (Kgs)	15.6
Wall Mounting	VESA 600 x 300 (mm)

* JBL speakers (full range and tweeter)



JBL is trademark of HARMAN International Industries, Incorporated, registered in the United States and/or other countries.



The terms HDMI, HDMI High-Definition Multimedia Interface, and the HDMI Logo are trademarks or registered trademarks of HDMI Licensing Administrator, Inc.



Quick Start Set Up Guide

For information on using the TV's features, please refer to the operating Instructions.

Model Numbers

55/405V-GB-11B4-UEGQPF

Register For Your
BLAUPUNKT
Manufacturers Warranty

Register your manufacturers guarantee online within 14 days of purchase at www.registertv.co.uk/blaupunkt

Quick & easy guide for setting up your TV

What is included in the box

Using the remote control

Setting up the TV for the first time - including attaching the stand

Connecting other devices to the Television

Need help setting up or using your TV?

Please contact the UK & ROI Helpline*

Telephone UK 0330 024 0802 or ROI 01443 3940

Online support at: www.umc-uk.co.uk

Email support at: service@umc-uk.co.uk

*Calls to 0330 numbers are charged at standard call rates and are included as part of any bundled minutes with your phone provider.

Calls to the ROI number are charged at the local call rate. The telephone opening hours are:

Monday to Friday 8.30am to 6pm

Saturday 9am – 5pm.

Bank Holidays - 10am to 4pm

Closed Christmas and New Years day



Please save your box/packaging as you will need this in the event of warranty/service repair or support. We are unable to carry out warranty/service if you are unable to package it correctly. The safest way to package your item in the event of warranty/service repair is in its original box/packaging.

Freewiew HD channels, in particular Freewiew HD channels, you will need a Digital TV aerial and be in a good Freewiew coverage area. You can check coverage for your postcode at www.freewiew.co.uk. Please note that any Freewiew HD channels found during tuning will be placed in channel positions above 100. For example, 101 (BBC1 HD), 102 (BBC2 HD) etc.

Your TV has a built in Personal Video Recording function, meaning you can set up recordings from the TV guide directly onto a PVR ready USB memory stick. You can also pause live TV and rewind/fast forward through your recordings. See our great range of tested and compatible PVR ready USB memory sticks at www.umc-uk.co.uk/usb

Content owners use Microsoft PlayReady™ content access technology to protect their intellectual property, including copyrighted content. This device uses PlayReady technology to access PlayReady-protected content and/or WMDRM-protected content. If the device fails to properly enforce restrictions on content usage, content owners may require Microsoft to revoke the device's ability to consume PlayReady-protected content. Revocation should not affect un-protected content or content protected by other content access technologies. Content owners may require you to upgrade PlayReady to access their content. If you decline an upgrade, you will not be able to access content that requires the upgrade.

This product contains technology subject to certain intellectual property rights of Microsoft. Use or distribution of this technology outside of this product is prohibited without the appropriate license(s) from Microsoft.

Should you wish to connect older/analogue devices to your television, you can purchase the necessary cables either from your retailer or at www.umc-uk.co.uk/cables

- Additional Accessories**
- 1 x Quick Start Guide
 - 1 x Remote Control and 2 x AAA Batteries
 - 1 x Stand installation pack:
 - 4 x [Image of screws]
 - 2 x [Image of brackets]

What is included in the box

Online Manual

To launch the Online Manual, press the [MENU] button and then select: Settings>About TV>Help Information>View Online Manual



If you wish to use your Sky remote to operate the TV's basic functions, you will need a Sky remote control (Revision 9 or later) and you will need to program it with the code 2134. If you wish to use your Sky Q remote to operate the TV's basic functions, you will need to program it with the code 4170.

Sky Remote Code



- ON/OFF** - Switch on the TV when in standby or vice versa. MUTE - Mute the sound or vice versa.
- NUMBER BUTTONS** - 0-9 to select a TV channel directly. TV GUIDE - Opens the 7 day TV guide (digital TV mode). - To return to the previous channel viewed.
- VOL (+/-)** - To increase/decrease the sound level. PICTURE - Scrolls through picture mode options. SOUND - Scrolls through sound mode options. SOURCE - To display the input/source menu. CH (+/-) - To increase or decrease the channel being watched. MENU - To display OSD menu. EXIT - To exit all menus. (FAV) (OK) - Allows you to navigate the on-screen menus and adjust the system settings to your preference. BACK - To go back a previous step. FAV - To display favourites menu.
- INFO** - Press once for now/next channel information. - Press twice for information about the current programme. TEXT - To enter/exit Text. SUBTITLE - To switch the dialogue at the bottom of the screen (on/off). TV - To switch to Digital Channels. YOUTUBE - Access the Youtube App. NETFLIX - Access the Netflix App. SMART - Access the Blaupunkt Smart Portal. RECORD - Access the USB record function. REC LIST - Opens the list of what has been previously recorded. - To restart the current chapter. - To advance forward to the next chapter. - To stop the playback/Eject Disc button for 4 seconds. - To play in fast forward mode. - To play/pause. GOTV - To go to a specific chapter. A-B - Press once to set point, press a second time to return to point. REPEAT - To repeat playback.

Setting up the TV set for the first time

To obtain a copy of your Operating Instructions, please go to: www.umc-uk.co.uk/instruction-manuals/blaupunkt

1 Fitting the stand

For stand installation, there are two types of screws provided as shown below. To complete the stand installation you will require a cross head screw driver.

Place the TV set on a flat and clean surface with the panel facing downwards to avoid damage.

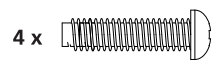

4 x Used for attaching the stand neck to the TV (fig.1)

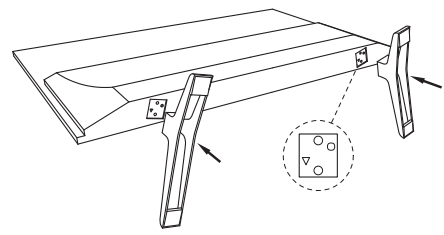

1 Place the TV set on a flat and clean surface with the panel facing downwards to avoid damage.

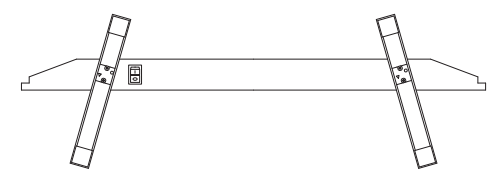

2 When the stand feet are installed correctly the stand feet will be longest at the front of the TV and shortest at the feet pointing away from each other.

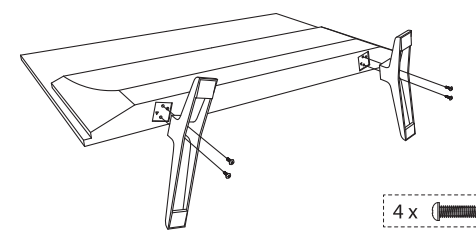

3 When the stand feet are in the correct position, secure the stand feet to the TV set using the 4 screws provided.



Register For Your
BLAUPUNKT
Manufacturers Warranty

Register your manufacturers guarantee online within 14 days of purchase at www.registertv.co.uk/blaupunkt

2 Installing batteries

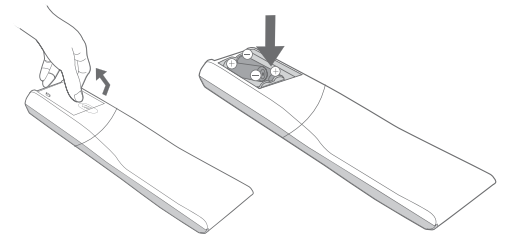

Remove the battery cover from the rear of the remote control and insert the AAA batteries which are supplied in the accessory pack. Ensure that the polarity of the batteries is as shown in the battery compartment. Replace the battery cover. The remote control is ready for use.

3 Connecting your set

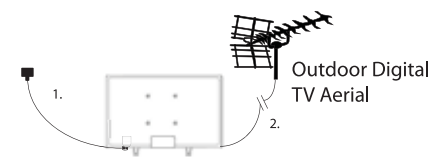

1) Connect the TV to your power socket.
2) If you wish to use the TV to receive Freeview/Saorview channels, connect the RF input from the TV to your outdoor Digital TV aerial. If you do not wish to receive Freeview/Saorview, skip this step.

4 Button Layout

- 1 Volume up and menu right
- 2 Volume down and menu left
- 3 Programme/Channel up and menu up
- 4 Programme/Channel down and menu down
- 5 Displays Menu/OSD
- 6 Displays the input source menu
- 7 Standby Power On/Off



Wall Mounting the TV

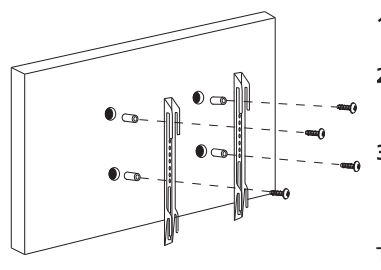

1. Remove the four screws that are supplied in the wall mounting holes.
2. The wall mount can now be easily attached to the mounting holes on the rear of the TV.
3. Install the wall mounting bracket to the television as advised by the bracket manufacturer.

Image for illustration only.

The picture shows the use of spacers, which are not applicable to all sets/installations.

5 First time installation

Basic installation steps are shown below. These may vary slightly depending on model.



1 Introduction

When the set first turns on, it enters the First Time Installation mode. This can be restarted by restoring the set to default settings in the 'About TV' Menu.

Note: In home mode, the TV will switch off automatically after 4 hours in the event that no buttons are pressed on the TV or remote control. (You can change this by pressing the [MENU] button and then selecting Settings > Time > Auto Standby)



4 Environment of Use

Home Mode: For normal use, by default it is set to a power saving mode which reduces the energy used by up to 25% (by reducing the power to the LED/LCD panel). This can be changed in the picture mode settings.



7 Default Source

Select the source which you use the most. If Digital TV (Freeview) is chosen, then at the next step, the set will tune in and default to Digital TV (Freeview). If one of the other sources is selected, then the set will not tune in at this stage and default to that input. If it is required to tune the set in later, press the [MENU] button and then select Settings > Channels



2 Languages

Select your preferred on-screen display language. This will change the language in which the menus and associated information is displayed in. When set up has been completed, to change this press the [MENU] button and then select Settings > System Menu > Language



5 Network setup

You can connect the TV to your broadband router or wireless network in order to take advantage of the Smart functions. If you connect the TV to your router using an Ethernet cable (recommended) this step will be skipped.



8 Tune in Channels

Choose to install terrestrial channels now or later.



3 Country Selection

Select the correct flag for the country in which the set will be used in. This will enable the set to correctly install the functions applicable in the country of use.

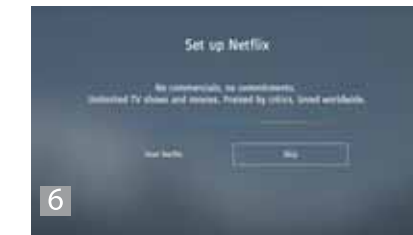

6 Set Up Netflix

If you have a Netflix account, it can be set up on the television here. Once set up and validated, the First Time Installation returns to the next step.



9 Support Advice

Information regarding support is displayed for a little while. Tuning continues and a progress bar is shown with the number of channels found indicated below.
If you are picking up signals from more than one transmitter, you will be requested to select your primary and secondary regions.

Connectivity

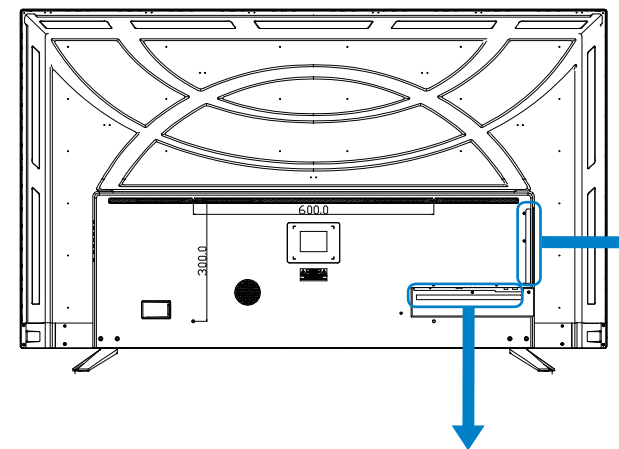

A	Ethernet/LAN*	Network connection	I	SAT IN	Satellite input
B	Digital Audio	Digital Optical Audio Output	J	RF in	RF / TV aerial input
C	USB 2.0	2 x USB port 2.0	K	HDMI 3	HDMI input (ARC)
D	HDMI 1	HDMI input	L	USB 2.0	USB port 2.0
E	HDMI 2	HDMI input	M	CI card in	Common interface module
F	YPbPr	HD input (YPbPr)	N	SD	SD card input
G	AV IN	Audio/Video input	O	Earphones	Earphone input
H	Mini SCART	Mini SCART input			

* The Ethernet/LAN port is used for Freeview HD services and smart functions.